

**PERSONAL LIGHTING SOLUTIONS
PROVIDER FOR SAFE DIVING**

ORCA TORCH

BORN TO CONQUER



/OrcaTorch



www.orcatorch.com

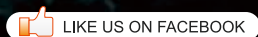

LIKE US ON FACEBOOK

ORCATORCH TECHNOLOGY LIMITED

Tel: +86-755-33560383 Fax: +86-755-29454989 Email: info@orcatorch.com www.orcatorch.com
Address: 7F, Building 6, Rundongsheng Industrial Park, Gushu, Xixiang, Baoan, Shenzhen, China (518102)

www.orcatorch.com

Content

New Release Dive Lights	05
Technical Dive Lights	11
U/W Photo/Video Dive Lights	17
Recreational Dive Lights	22



Introduction

OrcaTorch was founded by a group of passionate flashlight enthusiasts and technology geeks in 2014. The founder Carson Weng, is an outdoor enthusiast who has more than 10 years experience in the manufacture of high-end flashlights. When he was diving in Thailand for the first time in 2013, he found that divers were using low-quality dive lights which lacked innovation and usually did not work at the critical moments. He decided to use his talent in the flashlight industry and created a high-quality and innovative dive light brand and named it as OrcaTorch.

Orca, is a kind of whale that is fearless in challenging everything, free and unconstrained to parade all over the sea as it pleases. They conquer all the difficulties with team spirit and wisdom. They are the overlords of the sea and the best symbol of underwater adventure spirit.

Named after and inheriting the excellent characteristics of the Orca, which combine with advanced technology, OrcaTorch has developed a series of dive lights and underwater video lights that feature high brightness, long runtime, long beam distance, significant waterproofness, high impact resistance, and convenient operation. OrcaTorch advocates the spirit of 'follow your heart and just do it'. We love to explore the wonders of the world, feel the excitement of challenge and enjoy the freedom of life together with all underwater adventurers.

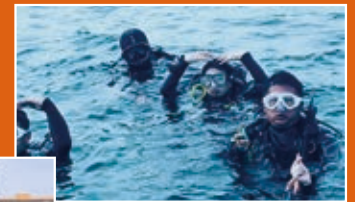

Product Advantages

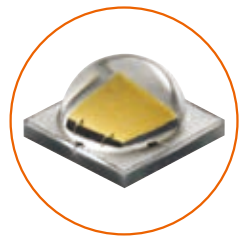

▶ CREE LED, Environment friendly, long lifetime and durable 50000 hours lifespan, 10 times as efficient as the ordinary LEDs

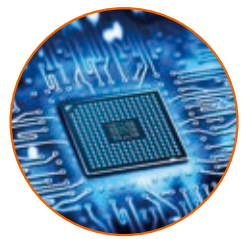

▶ High-efficiency constant current circuit instead of PWM circuit
Constant brightness without flicker.

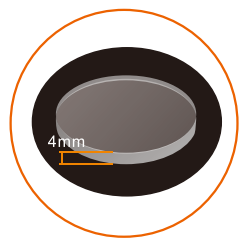

▶ Two sides coated toughened glass with high water pressure resistance.
Water pressure resistant construction ,depth rated to 150 meters.



▶ Alloy aluminum reflector with professional optical analysis.

Manufacturing process

OrcaTorch lights use aircraft-grade aluminum AL-6061-T6 with light weight and high strength. All lights adopt premium Type III military hard-anodized finish which is better anti-abrasive than normal anodization and performs well in extreme environment. We also upgrade the finish of diving light to latest diamond grade seawater-corrosion-resistance hard anodized finish which is thicker and denser than normal Premium Type III military hard anodization, making the light surface as tough as diamond to protect the light from seawater corrosion.

Testing standard

OrcaTorch's stated data has been measured according to the international flashlight test standards (ANSI/NEMA FL1) under laboratory conditions.

Warranty

We will replace products afflicted with manufacturing defects within 30 days of purchase and repair a light free of charge within 12 months of purchase if problems develop under normal use.
If you register your OrcaTorch products through our official website www.orcatorch.com, you will get extra 12 months and totally 2 years warranty.

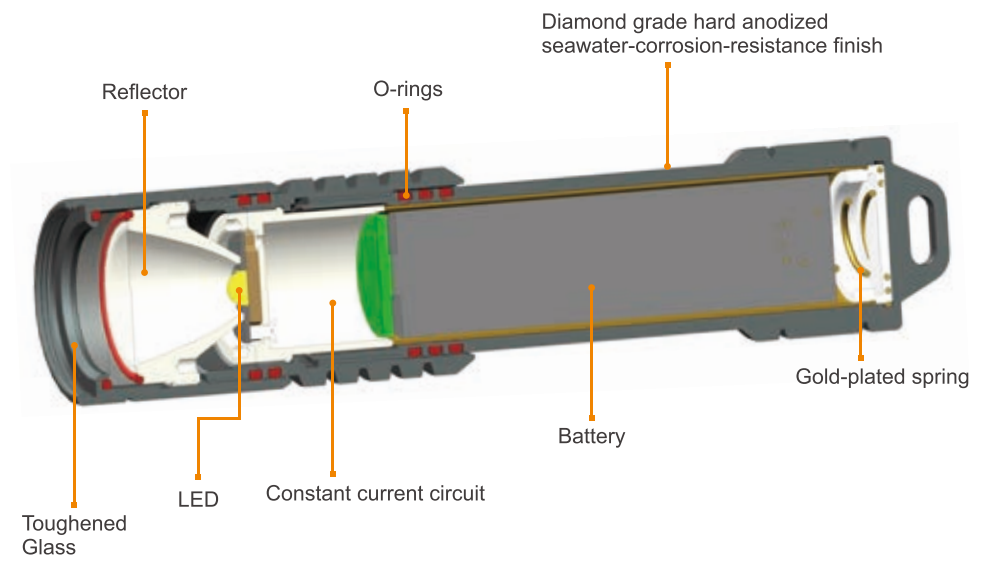

New Release Dive Lights



D640 Max 1000 lumens

Main Features:

- ◆ Focus Canister Dive Light
- ◆ 180° Head Rotating
- ◆ 10°-55° Beam Angle Adjustable

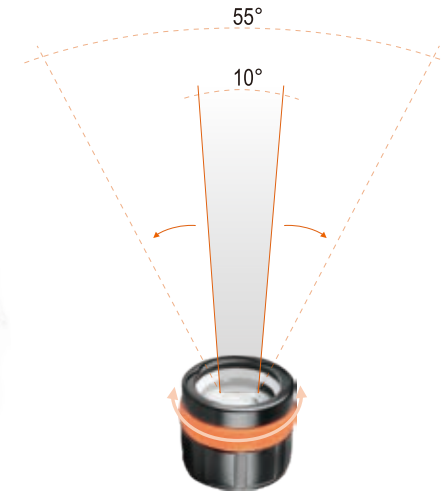

SD01 Mini glow tank

Main Features:

- ◆ Powered by 1*AAA battery
- ◆ Runtime 108 hours
- ◆ Size: 77.5mm(Length)*19mm(Diameter)
- ◆ Net Weight:23.5g
- ◆ Accessories: O-rings, lanyard, AAA battery incl.
- ◆ Available Colors:Blue, Red, Green, White, Orange
- ◆ Waterproof underwater 150m(500 feet)



D700 Max 1700 lumens



Main Features:

- ◆ Uses CREE LED, max 1700 lumens
- ◆ Uses 1*21700 5000mAh USB charging battery
- ◆ 6° beam angle
- ◆ Mechanically head rotary switch offers high reliability underwater
- ◆ Intelligent Over-Heat protection
- ◆ Water pressure resistant construction , depth rated to 150 meters



21700 USB Charging Battery



ANSI/NEMA FL1	Mode
☀️ Output	1700 lumens
🕒 Runtime	1h 50mins
🌊 Waterproof	Underwater 150m
📏 Dimension	142mm(Length)*27mm(Tube)*36mm(Head)
⚖️ Net Weight(Flashlight)	135g
🧰 Accessories	1*21700 battery, USB Cable, Lanyard, Spare O-rings, Brand rubber bands

Color Tperature 6500K

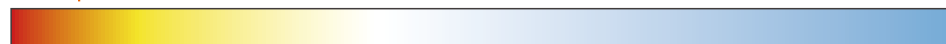

1800K 4000K 6500K 8000K 12000K

D710 Max 3000 lumens



Main Features:

- ◆ Uses CREE LED, max 3000 lumens
- ◆ Uses 1*21700 5000mAh USB charging battery
- ◆ 6° beam angle
- ◆ Easy operation with side titanium alloy button switch
- ◆ Safe lock function, prevents mis-operation
- ◆ Intelligent Over-Heat protection
- ◆ Water pressure resistant construction , depth rated to 150 meters



Battery Indicator

Side Titanium Alloy Button Switch



ANSI/NEMA FL1	Turbo	High	Middle	Low
☀️ Output	3000 lumens	1700 lumens	800 lumens	400 lumens
🕒 Runtime	1min+1h 40mins	1h 40mins	3h 40mins	7h 40mins
🌊 Waterproof	Underwater 150m			
📏 Dimension	154.9mm(Length)*27mm(Tube)*36mm(Head)			
⚖️ Net Weight(Flashlight)	152g			
🧰 Accessories	1*21700 battery, USB Cable, Lanyard, Spare O-rings, Brand rubber bands			

Color Tperature 6500K

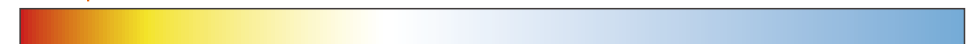

1800K 4000K 6500K 8000K 12000K 16000K

D511 Max 2200 lumens



Main Features:

- ◆ Uses CREE LED, max 2200 lumens
- ◆ Use 2* 26650 battery, compatible with 3* C battery
- ◆ 8° beam angle
- ◆ Mechanically head rotary switch offers high reliability underwater
- ◆ Intelligent Over-Heat protection
- ◆ Water pressure resistant construction , depth rated to 150 meters

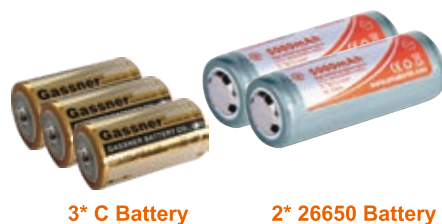

3* C Battery

2* 26650 Battery



ANSI/NEMA FL1	3°C Battery	2*26650 Battery
☀️ Output	900 lumens	2200 lumens
🕒 Runtime	5h 30mins	3h 10mins
🛡️ Waterproof	Underwater 150m	
📏 Dimension	197mm(Length)*34mm(Tube)*51mm(Head)	
⚖️ Net Weight(Flashlight)	274g	
🧰 Accessories	2* 26650 battery, Lanyard, Spare O-rings, Brand rubber bands	

Color Tperature 6500K

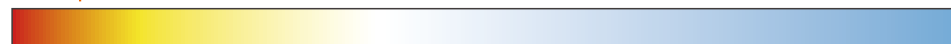

1800K 4000K 6500K 8000K 12000K

D580 Max 530 lumens



Main Features:

- ◆ Uses CREE LED, max 530 lumens
- ◆ Uses 3*AAA battery, compatible with 1*18650 battery
- ◆ 6° beam angle
- ◆ Mechanically head rotary switch offers high reliability underwater
- ◆ Intelligent Over-Heat protection
- ◆ Water pressure resistant construction , depth rated to 150 meters



Mechanically Head Rotary Switch



ANSI/NEMA FL1	3*AAA Battery	18650Li-ion battery
☀️ Output	480 lumens	530 lumens
🕒 Runtime	2h 50mins	3h 30mins
🛡️ Waterproof	Underwater 150m	
📏 Dimension	128.5mm(Length)*27mm(Tube)*35.5mm(Head)	
⚖️ Net Weight(Flashlight)	125g	
🧰 Accessories	3*AAA battery, Battery shield, Lanyard, Spare O-rings, Brand rubber bands	

Color Tperature 6500K

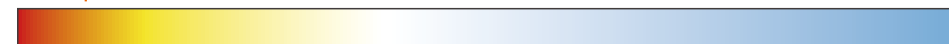

1800K 4000K 6500K 8000K 12000K 16000K

Technical Dive Lights



D630 Max 4000 lumens



90° ~180° Angle Adjustable Cable

- Main Features:**
- ◆ 5* CREE LEDs, max 4000 lumens
 - ◆ 90°~180° angle adjustable cable
 - ◆ Suitable for both back mount and side mount diving
 - ◆ 7° super focus beam
 - ◆ LED indicator offers an instant update of battery status
 - ◆ 89Wh rechargeable large capacity battery pack
 - ◆ 5 hours long runtime at brightest mode
 - ◆ Battery can be used as a power bank
 - ◆ Battery charging indicator displays the charging status

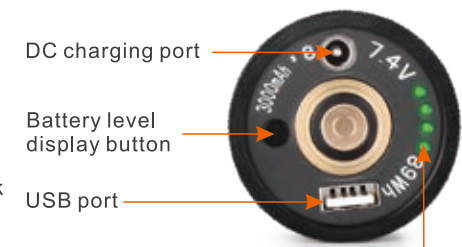

DC charging port
 Battery level display button
 USB port
 Battery level indicator

Large Capacity Battery Pack



ANSI/NEMA FL1	High	Middle	Low
☀️ Output	4000 Lumens	1500 Lumens	460 Lumens
🕒 Runtime	5h	7h 26min	23h 50min
📏 Beam Distance	514m (On land)		
📡 Intensity	66080 cd		
Charging time	4h		
Dimension	Canister: 209mm(Length) x 59mm(Diameter) Torch: 96mm(Length) x 60mm(Diameter)		
Net weight	1.37Kg(Including battery pack)		
Weight in water	0.6Kg (Including battery pack)		
Accessories	Rechargeable battery pack, Goodman handle, Spare O-rings, Charger		



D620 Max 2700 lumens



Main Features:

- ◆ Cree LED, 2700 lumens output
- ◆ Uses four 18650 Li-ion batteries
- ◆ 90° rotary lockable switch offers easy and reliable operation
- ◆ Easy-pack adjustable rotary goodman handle



D620

D620V

OrcaTorch D620V is specially designed for underwater photography, 120 degrees super wide beam angle with no hot spot.

ANSI/NEMA FL1	High	Middle	Low
Output	2700 Lumens	800 Lumens	150 Lumens
Runtime	2h30min	8h50min	37h
Beam Distance	260m (On land)		
Intensity	16870 cd		
Dimension	Light head: 83mm(Length) x 50mm(Diameter) Canister: 113mm(Length)x54mm(Diameter)		
Net weight	681g(excluding battery)		
Accessories	Four 18650 batteries, charger, handle, Spare O-rings		

Color Temperature 6000K



1800K 4000K 6500K 8000K 12000K 16000K

D860 Max 4200 lumens



Main Features:

- ◆ 3* CREE high power LED, max 4200 lumens
- ◆ Direct charging system with a short charging time of 3.5 hours
- ◆ Replaceable INR battery pack
- ◆ Titanium alloy tail button switch, easy operation
- ◆ Safe lock function avoids misoperation
- ◆ Specially designed handle, easy to carry and assemble
- ◆ Battery indicator



ANSI/NEMA FL1	High	Middle	Low
Output	4200 Lumens	1500 Lumens	500 Lumens
Runtime	1h	4h30min	14h
Beam Distance	310m (On land)		
Intensity	24000 cd		
Charging time	3.5 hours		
Dimension	189mm(Length) x 51mm(Diameter) x 64mm(Head)		
Net weight	773g		
Weight in water	345g		
Accessories	Battery pack, home charger, lanyard, Spare O-rings		

Color Temperature 6000K



1800K 4000K 6500K 8000K 12000K 16000K

D850 Max 2500 lumens



6° Super Focus Beam Angle

Main Features:

- ◆ 5* Cree high power LED, max 2500 lumens
- ◆ Uses 2*26650 li-ion rechargeable batteries
- ◆ Super focus optical design provides 6 degrees beam angle
- ◆ Titanium alloy side button switch, anti-corrosion and stable
- ◆ Safe lock function, prevents accidental operation
- ◆ Battery indicator



Goodman handle (Optional accessory)



ANSI/NEMA FL1	High	Middle	Low
☀️ Output	2500 Lumens	1050 Lumens	300 Lumens
🕒 Runtime	3h30min	5h	13h30min
📏 Beam Distance	464m (On land)		
👁️ Intensity	53900 cd		
Dimension	228mm(Length) x34mm(Diameter) x60mm(Head)		
Net weight	453g(excluding battery)		
Weight in water	355g(excluding battery)		
Accessories	2*26650 batteries, charger, lanyard, Spare O-rings		

Color Temperature 6000K



1800K 4000K 6500K 8000K 12000K 16000K

D800 Max 2100 lumens



Mechanically tail rotary switch

Main Features:

- ◆ 3*Cree LED, 2100 lumens output
- ◆ Uses 2*26650 batteries
- ◆ Mechanical tail rotary switch offers high reliability underwater
- ◆ Aircraft-grade high strength aluminum material
- ◆ Over-discharge protection function



3*Cree LED, 2100 lumens output



ANSI/NEMA FL1	Mode
☀️ Output	2100 Lumens
🕒 Runtime	3h20min
📏 Beam Distance	336m (On land)
👁️ Intensity	28270cd
Dimension	222mm(Length) x 34mm(Diameter) x 66mm(Head)
Net weight	462g (excluding battery)
Accessories	2*26650 batteries, charger, Spare O-rings, lanyard

Color Temperature 6000K



1800K 4000K 6500K 8000K 12000K 16000K

U/W Photo/Video Dive Lights



D530V Max 1200 lumens



- Main Features:**
- ◆ CREE LED, max 1200 lumens
 - ◆ Uses 1*18650 Li-ion rechargeable battery
 - ◆ 140°super wide beam angle
 - ◆ Easy operation with side titanium alloy button switch
 - ◆ Battery indicator

ANSI/NEMA FL1	High	Low
☀️ Output	1200 Lumens	290 Lumens
🕒 Runtime	1h24min	4h36min
📏 Dimension	142mm(Length) x 25.5mm(Diameter) x 35.5mm(Head)	
⚖️ Net weight	145g(excluding battery)	
🧰 Accessories	One USB rechargeable 18650 Li-ion battery, USB cable, lanyard, Spare O-rings	



D950V Max 10500 lumens



CREE COB LED
Max 10500 lumen output

Main Features:

- ◆ CREE COB LED, Max 10500 lumen output
- ◆ Spherical toughened glass optical lens design, 120° wide angle beam
- ◆ Color temperature 5700K, CRI Ra92
- ◆ Built-in replaceable large capacity battery pack
- ◆ Tail switch controls 4 brightness modes
- ◆ Tail LED indicator instantly displays the battery's remaining charge



ANSI/NEMA FL1	Turbo	High	Middle	Low
☀️ Output	10500 Lumens	6200 Lumens	3000 Lumens	1100 Lumens
🕒 Runtime	1h12min	1h54min	3h50min	10h
🔋 Charging time	3h10min			
📏 Dimension	255mm(Length) x 53mm(Diameter) x 72mm(Head)			
⚖️ Net weight	1059g (excluding battery)			
💧 Weight in water	495g (Including battery)			
🧰 Accessories	Battery pack, home charger, ball joint, OrcaTorch rubber ring, Spare O-rings			

Color Temperature 5700K



1800K 4000K 6500K 8000K 12000K 16000K

D910V Max 5000 lumens



COB LED 5700K CRI: Ra92

Main Features:

- ◆ CREE COB LED, Max 5000 lumens
- ◆ 120° wide angle beam
- ◆ Color temperature 5700K, CRI Ra92
- ◆ Magnetic fast charging system with a short charging time of 2.5h
- ◆ Standard included battery pack
- ◆ Titanium alloy switch controls 3 lighting modes



Magnetic fast-charging system



ANSI/NEMA FL1	High	Middle	Low
☀️ Output	5000 Lumens	2000 Lumens	500 Lumens
🕒 Runtime	50min	2h10min	8h50min
🔋 Charging time	2.5 hours		
📏 Dimension	129.5mm(Length) x 45mm(Diameter) x 53mm(Head)		
⚖️ Net weight	430g		
💧 Weight in water	215g		
🧰 Accessories	home charger, ball joint, OrcaTorch rubber ring, Spare O-rings		

Color Temperature 5700K

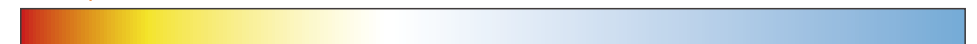

1800K 4000K 6500K 8000K 12000K 16000K

D900V Max 2200 lumens

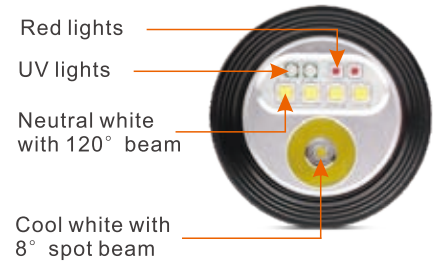

Main Features:

- ◆ Max 2200 Lumens
- ◆ Red, UV, Neutral white with 120° flood beam
- ◆ Cool white with 8° spot beam
- ◆ Magnetic fast charging system with a short charging time of 2.5h
- ◆ Standard included a battery pack
- ◆ Dual titanium alloy switch controls different lighting sources independently

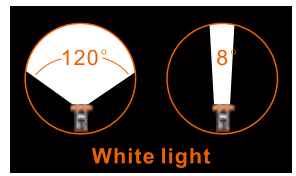
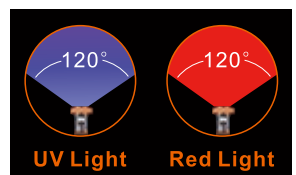

ANSI/NEMA FL1	Neutral White (flood beam)		Cool White (spot beam)		Red	UV
	High	Low	High	Low		
Output	2200 Lumens	600 Lumens	820 Lumens	250 Lumens	250 Lumens	-
Runtime	2h45min	4h20min	4h	18h	7h	5h
Beam Distance	230m (On land)					
Intensity	13640 cd					
Charging time	2.5 hours					
Dimension	129.5mm(Length) x 45mm(Diameter) x 53mm(Head)					
Net weight	430g					
Weight in water	215g					
Accessories	home charger, ball joint, OrcaTorch rubber ring, Spare O-rings					

Color Teperature 5000K



Recreational Dive Lights



D520 Max 1000 lumens



color: ■ ■ ■ ■

Main Features:

- ◆ Cree LED, max 1000 lumens output
- ◆ Uses 1*18650/2*CR123A/2*16340 battery
- ◆ Mechanical head rotary switch offers high reliability underwater



ANSI/NEMA FL1	Mode
☀️ Output	1000 lumens
🕒 Runtime	2h
📏 Beam Distance	250m (On land)
👁️ Intensity	14300cd
📏 Dimension	134.5mm(Length) x 24mm(Diameter) x 30mm(Head)
⚖️ Net weight	113.5g (excluding battery)
📦 Accessories	18650 battery, charger, Spare O-rings, lanyard

Color Temperature 5000K

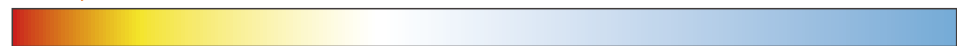

1800K 4000K 6500K 8000K 12000K 16000K

D530 Max 1300 lumens



Main Features:

- ◆ Cree LED, max 1300 lumens
- ◆ Uses 1*18650 Li-ion rechargeable battery
- ◆ 8° super focus beam angle
- ◆ Easy operation with side titanium alloy button switch
- ◆ Battery indicator



Powered by One 18650 USB Battery



ANSI/NEMA FL1	High	Low
☀️ Output	1300 Lumens	380 Lumens
🕒 Runtime	1h25min	4h30min
📏 Beam Distance	291(on land)	
👁️ Intensity	21164 cd	
📏 Dimension	142mm(Length) x 25.5mm(Diameter) x 35.5mm(Head)	
⚖️ Net weight	136g (Excluding Battery)	
📦 Accessories	One USB Rechargeable 18650 Li-ion battery, Micro USB Cable, Lanyard, Spare O-rings	

Color Temperature 6000K

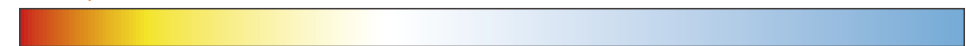

1800K 4000K 6500K 8000K 12000K 16000K

D550 Max 1000 lumens



Main Features:

- ◆ Cree LED, 1000 lumens output
- ◆ Uses one 18650 battery
- ◆ Magnetic controlled tail switch offers high waterproofness and easy operation underwater
- ◆ Standard included wrist strap fastens the flashlight to the back of your hand



ANSI/NEMA FL1	High	Low	Strobe
Output	1000 Lumens	367 Lumens	1000 Lumens
Runtime	2h5min	5h45min	/
Beam Distance	253m (On land)		
Intensity	16000cd		
Dimension	146mm(Length) x 25.4mm(Diameter) x 40mm(Head)		
Net weight	183g (excluding battery)		
Accessories	18650 battery, charger, Wrist strap, Spare O-rings, lanyard		

Color Tperature 6000K

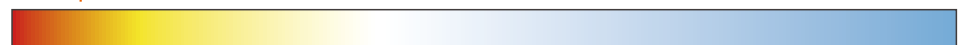

1800K 4000K 6500K 8000K 12000K 16000K

D560-GL



Main Features:

- ◆ Green Laser with 520nm wavelength
- ◆ Uses a single AA battery or a 14500 Li-ion battery
- ◆ Mechanical head rotary switch offers high-reliability underwater



Laser Only

Battery Model		AA battery	14500 battery
Runtime	D560-GL	5h20min	5h
	D560-RL	10h24min	17h30min
Beam Distance	>1000m(On land)		
Dimension	92mm(Length) x 20mm(Diameter) x 24mm(Head)		
Net weight	50g (excluding battery)		
Accessories	2*AA batteries, Lanyard, Spare O-rings,		

ORCA TORCH also provides option of Red Laser D560-RL.

D560 Max 630 lumens



color: ■ ■ ■

Main Features:

- ◆ Mini dive light with only 9 cm long, 47.5g
- ◆ Cree LED, 630 lumens output
- ◆ Uses a single AA battery or a 14500 Li-ion battery
- ◆ Mechanical head rotary switch offers high reliability underwater



**Mx05 Mask mount
(Optional accessory)**

ANSI/NEMA FL1	AA battery	14500 battery
Output	180 Lumens	630 Lumens
Runtime	1h25min	1h
Beam Distance	73m (On land)	119m (On land)
Intensity	1320cd	3520cd
Dimension	92mm(Length) x 20mm(Diameter) x 24mm(Head)	
Net weight	47.5g (excluding battery)	
Accessories	Spare O-rings, lanyard	

Color Tperature 6000K

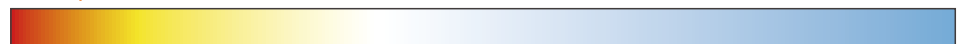

1800K 4000K 6500K 8000K 12000K 16000K

D570-GL Max 1000 lumens



Multiple Applications



On Land



Rescue Signal



Instructor Guide

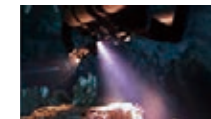

Underwater Lighting



Attracting Sea Animals

Main Features:

- ◆ Two light sources :8°white beam + green laser light
- ◆ Easy operation with side button switch
- ◆ Battery indicator
- ◆ Intelligent Over-Heat protection



ANSI/NEMA FL1	White	laser
Output	1000 Lumens	-
Runtime	1h51min	13h36min(D570-GL) 80h(D570-RL)
Beam Distance	281(on land)	>1000m(on land)
Intensity	19800 cd	-
Dimension	134mm(Length) x 26mm(Diameter) x 40mm(Head)	
Net weight	176g(excluding battery)	
Accessories	One 18650 Li-ion battery, charger, lanyard, Spare O-rings	

ORCA TORCH also provides option of Red Laser D570-RL.

Color Temperature 5000K



1800K 4000K 6500K 8000K 12000K 16000K

Accessories



**SH01, SH02, SH03
Snap Hook**



**21700 USB
Charging Battery**



**18650 USB Battery
3400 mAh**



M03 Ball Joint



WS01



**H620
Goodman Handle**



**ZJ13
Ball Joint Clamp**



**H01
Tray with Handles**



HM01 Helmet Mount



**ZJ18
Ball Joint Bracket**



**P11
Scuba Diving Pointer**



**Waterproof Dry Bag
(5L)**

Model	Max Output	Max Runtime	Modes	Waterproof	Dimension	Net Weight	Battery	Model
D520	1000 Lumens	2h	1	150m	134.5X24X30(mm)	113.5g	1*18650 / 2*CR123A / 2*16340	D520
D530	1300 Lumens	4h30min	2	150m	142x 25.5x 35.5(mm)	136g	1*18650	D530
D530V	1200 Lumens	4h36min	2	150m	142x 25.5x 35.5(mm)	145g	1*18650	D530V
D550	1000 Lumens	5h45min	3	150m	146mX25.4X40(mm)	183g	1*18650	D550
D560	630 Lumens	1h25min	1	150m	92X20X24(mm)	47.5g	1*AA / 1*14500	D560
D560-GL	-	5h	1	150m	92mX20X24(mm)	50g	1*AA/1*14500	D560-GL
D560-RL	-	17h30min	1	150m	92mX20X24(mm)	50g	1*AA/1*14500	D560-RL
D570-GL	1000 Lumens	11h36min	2	150m	134X26X40(mm)	176g	1*18650	D570-GL
D570-RL	1000 Lumens	80h	2	150m	134X26X40(mm)	176g	1*18650	D570-RL
D611	2400 Lumens	22h	3	150m	light head: 82X50(mm) canister: 194X40(mm)	580g	2*26650	D611
D620	2700 Lumens	37h	3	150m	light head: 83X50(mm) canister: 113X54(mm)	681g	4*18650	D620
D630	4000 Lumens	23h50min	3	150m	Light Head: 96mm x 60mm Canister: 209mm x 59mm	1370g	Battery pack	D630
D800	2100 Lumens	3h20min	1	150m	222X34X66(mm)	462g	2*26650	D800
D820V	1600 Lumens	6h40min	4	150m	153X30X45(mm)	250g	1*rechargeable battery	D820V
D850	2500 Lumens	13h30min	3	150m	228X34X60(mm)	453g	2*26650	D850
D860	4200 Lumens	14h	3	150m	189X51X64(mm)	773g	Battery pack	D860
D900V	2200 Lumens	18h	6	150m	129.5X45X53(mm)	430g	Battery pack	D900V
D910V	5000 Lumens	8h50min	3	150m	129.5X45X53(mm)	430g	Battery pack	D910V
D950V	10500 Lumens	10h	4	150m	255X53X72(mm)	1059g	Battery pack	D950V
D640	1000 Lumens	3h30mins	2	150m	Light Head:115.8x 53.5(mm) Canister: 210x 56(mm)	1.36kg	Battery pack	D640
D511	2200 Lumens	3h10mins	1	150m	197*34m *51(mm)	274g	2*26650/3*C	D511
D710	3000Lumens	7h42mins	4	150m	154.9*27*36(mm)	152g	1*21700	D710
D700	1700Lumens	1h50mins	1	150m	142*27*36(mm)	135g	1*21700	D700
D580	530Lumens	3h30mins	1	150m	128.5*27*35.5(mm)	125g	1*18650/3*AAA	D580